



4MTARS lens, FEPU end plug and LCW latches shown.

Description

The Sentry series is A.L.P.'s flagship gasketed enclosure. The Gear Tray type combines cost effectiveness with functional practicality by minimizing required internal metal components versus Strip Type enclosures. The Sentry housing is sealed against dust and moisture and available in a variety of lens, latch, wire-entry, and lamp configurations.

Applications

Ideal for use in dusty, dirty, or wet environments including food processing, cold storage, kitchens, parking garages, car washes, covered canopies, pedestrian tunnels, concourses, and industrial.

Certifications

- UL/cUL recognized component
- Wet Location listed
- IP65 (Standard 6-latch configuration)
- IP66 & IP67 (Optional 8-latch configuration)
- NSF International certified for NSF/ANSI Standard 2 – Food Equipment

Features

- Rigid one piece housing construction.
- Standard 6-latch (IP65) or optional 8-latch (IP66 & IP67) housings.
- En-seal™ gasketing provides superior resistance to moisture absorption versus conventional gasketing.
- Standard suitcase style latches.
- Molded latch pockets compatible with standard and tamper-proof latches in Celcon, stainless steel, and polycarbonate.
- Internal gear tray mounts to #10-32 brass stud molded into housing by two plastic or steel Traylats.
- Gear tray suspends from housing by two security straps during servicing.

Lamp Configurations

Lamp Type	1-Lamp	2-Lamp	3-Lamp
T5/T5HO	■	■	■
T8	■	■	■
T8 HO	■	■	

Housing

Compression molded self-extinguishing fiberglass reinforced polyester compound with UL 5V flame rating (ASTM D635-74). F1 weatherability rating.

Gasketing

En-Seal™ continuous perimeter poured gasket assures lens seal to housing.

Electrical Chassis

Gear trays constructed of 83% reflective, 22-gauge, pre-painted steel.

Conduit Entry

Standard housings available with one 7/8" conduit entry point on either or both ends. Consult Sales for other opening sizes or for top openings.

Lens

Inline thermal-formed lenses available in tapered, shallow and deep profiles or crepe pattern acrylic, DR reinforced acrylic, frosted acrylic, or prismatic polycarbonate.

Mounting

Standard stainless steel bracket (BRKTS22PK) for surface or all-thread pendant mounting or optional galvanized steel bracket (BRKT 1) for surface mounting. Consult Sales for chain or cable mounting options.

Optional Reflectors

Optional Miro4 reflector available for improved optical efficiency and distribution uniformity.

Please contact A.L.P. for pricing and delivery.

All specifications subject to change without notice. A.L.P. assumes no responsibility for these materials in any luminaire or application.

The product is an OEM component kit requiring final assembly by a qualified OEM fixture manufacturer.

EXPLODED VIEW

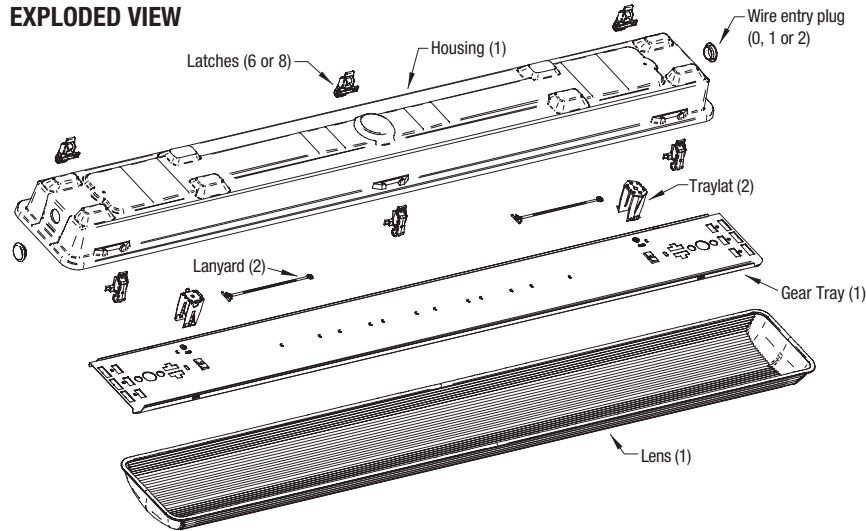

TOP VIEW

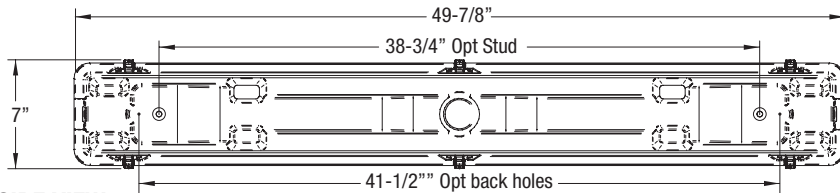

SIDE VIEW

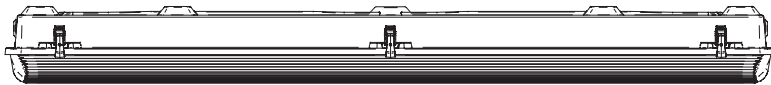

END VIEW

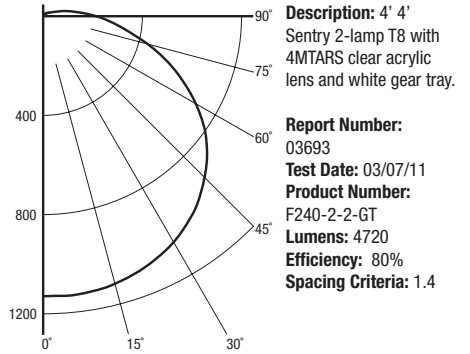
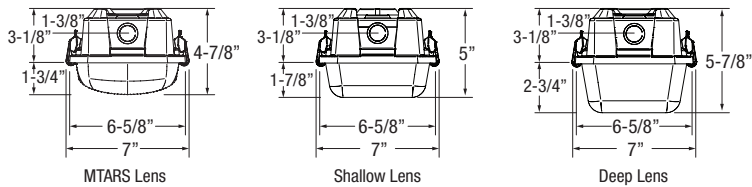

Zonal Lumen Summary

Zone	Lumens	%Fixt
0-30	927	19.6
0-40	1568	33.2
0-60	3001	63.6
0-90	4403	93.3
90-120	290	6.1
90-130	307	6.5
90-150	316	6.7
90-180	316	6.7
0-180	4720	100.0

Luminance Data

in Candela/SQ M at 0° plane

Angle	Average
45	6045
55	6456
65	6874
75	7911
85	14868

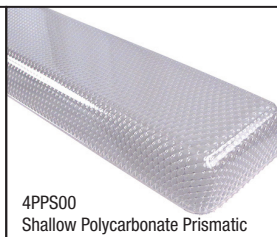

HOUSING (Select One) Contact Sales to order housing with top holes, 1-1/8" or 1-1/4" holes, or back studs.					
Part Number	Description	IP Rating	End Wiring Holes	Qty/Case	Kit
4F-0-GT	4' Sentry housing	IP65 ¹	None	30	
4F-1-GT	4' Sentry housing	IP65 ¹	7/8" hole on one end only	30	
4F-18-GT	4' Sentry housing	IP66 and IP67 ²	7/8" hole on one end only	30	
4F-2-GT	4' Sentry housing	IP65 ¹	7/8" hole on both ends	30	1
4F-28-GT	4' Sentry housing	IP66 and IP67 ²	7/8" hole on both ends	30	
GEAR TRAY (Select one)					
Part Number	Description	Lamp Configuration	Qty/Case	Kit	
SENTRYGT4	4' Sentry gear tray	2-lamp T8	250		
SENTRYGT4U	4' Sentry gear tray	1-3 lamp T5/T8 ³	250	1	
SENTRYGT41HO	4' Sentry gear tray	1-lamp T8 HO	160		
SENTRYGT4HO	4' Sentry gear tray	2-lamp T8 HO	160		
LATCHES (Select six for IP65 housings or eight for IP66/IP67 housings)					
Part Number	Description	Kit			
LCW	White Celcon latch	6			
LCWTP3	Tamper-proof white Celcon latch with nut and screw				
LPC	White polycarbonate latch				
LPCTP3	Tamper-proof white polycarbonate latch with nut and screw				
LSS-3	Stainless steel latch				
LSS-3TP	Tamper-proof stainless steel latch with nut and screw				
WIRE ENTRY PLUGS (Select none, one or two depending on housing selected)					
Part Number	Description	Kit			
FEPW	White 7/8" dry location plug				
LTP088	White 7/8" liquid tight plug	2			
DC-2A	7/8" die cast aluminum fitting assembly for 1/2" rigid conduit ⁴				
LTF-01 Bulk Kit	7/8" liquid tight power cord fitting				
FQC WOG-S	Flexible quick connector for 1/2" EMT. See FMC sheet for other configs. ⁶				
LENS (Select one)					
Part Number	Description	Qty/Case	Kit		
4MTARS_	4' Tapered acrylic lens with prismatic lengthwise pattern & crepe end pattern. Indicate EX for 100% DR, HI for 50% DR, MI for 15% DR, 100F for Frosted, PC for Polycarbonate	50	1 ⁹		
4ARS_	4' Shallow acrylic lens in crepe pattern. Indicate 00 for 50% DR or 15 for 15% DR	30			
4PPS00	4' Shallow polycarbonate lens in prismatic pattern	30			
4PPD00	4' Deep polycarbonate lens in prismatic pattern	20			
4ARD_	4' Deep acrylic lens in crepe pattern. Indicate 00 for 50% DR or 15 for 15% DR	30			
HOUSING MOUNTING BRACKET (Select one)					
Part Number	Description	Qty/Case			
BRKTS22PK	Sentry stainless steel strap bracket, 2-pack	80			
BRKT 1	External stud mounting bracket ⁷	100			
MISCELLANEOUS PARTS					
Part Number	Description				
TRAYLAT	White Celcon gear tray mounting clip, 2-pack ⁵				
TRAYLATSS	Stainless steel gear tray mounting clip, 2-pack ⁵				
LANYARD	White Celcon security strap, 2-pack				
NUT1001	#10-32x3/8" steel hex locking nut for TRAYLAT attachment to housing				
SC8GND	#8-32x3/8" green ground screw				
GEARTRAY-HDW	Gear tray hardware kit: contains (2) TRAYLAT and (2) LANYARD	1			
OPTIONAL REFLECTORS					
Part Number	Description	Qty/Case			
GT-4FREFL	4' Miro 4 reflector ⁸	100			
OPTIONAL ACCESSORIES					
Part Number	Description				
TAMPER BIT 3	Driver bit for TAMPERPRUF screw used in LCWTP3, LPCTP3, & LSS-3TP				
TAMPER BIT 8	Driver bit for tamper-proof snake eye drive screw, compatible with LSS-3				

Ordering Notes:

- Requires six latches.
- Requires 8 latches.
- Requires TRAYLATSS stainless steel tray mounting clips
- Apply silicone sealant to internal threads for wet location use.
- Requires NUT1001 nut.
- Requires housing with 1-1/4" end opening(s); Contact Sales.
- Requires housing with external brass stud. Contact Sales.
- Compatible with SENTRYGT4U & SENTRYGT4 gear trays only.
- 4MTARSMI lens included in kit.

Quantities are one each unless otherwise indicated.

Kit: F240-2-GT

GEAR TRAYS

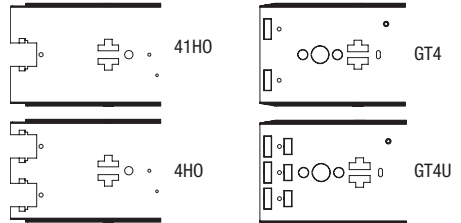

LATCHES

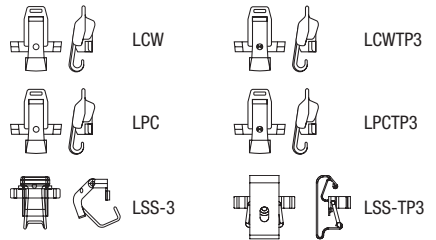

WIRE ENTRY PLUGS

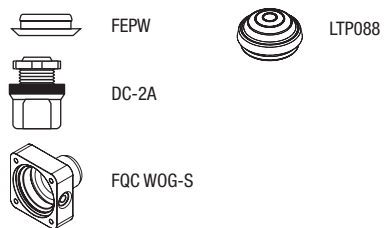

LENSES

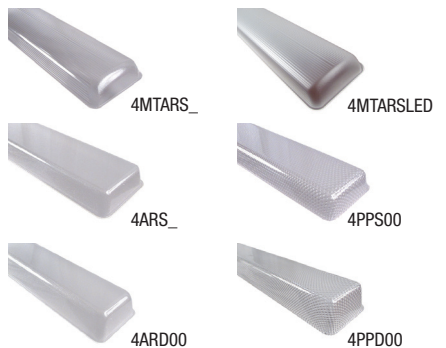

HOUSING MOUNTING BRACKETS



MISCELLANEOUS PARTS

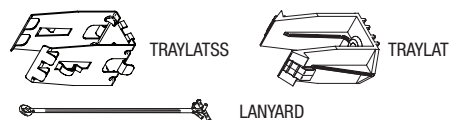

OPTIONAL ACCESSORIES

